

APPROVALS		DATE		TITLE	
DRAWN	GLM	DATE	081502	MPC566EVB AXM-0286	
CHECKED	PDF	DATE	081502	SIZE	D
DESIGNED	PDF	DATE	081502	DWG NO	AX-SCH-0276
SCALE				REV	B
SHEET				2 OF 6	

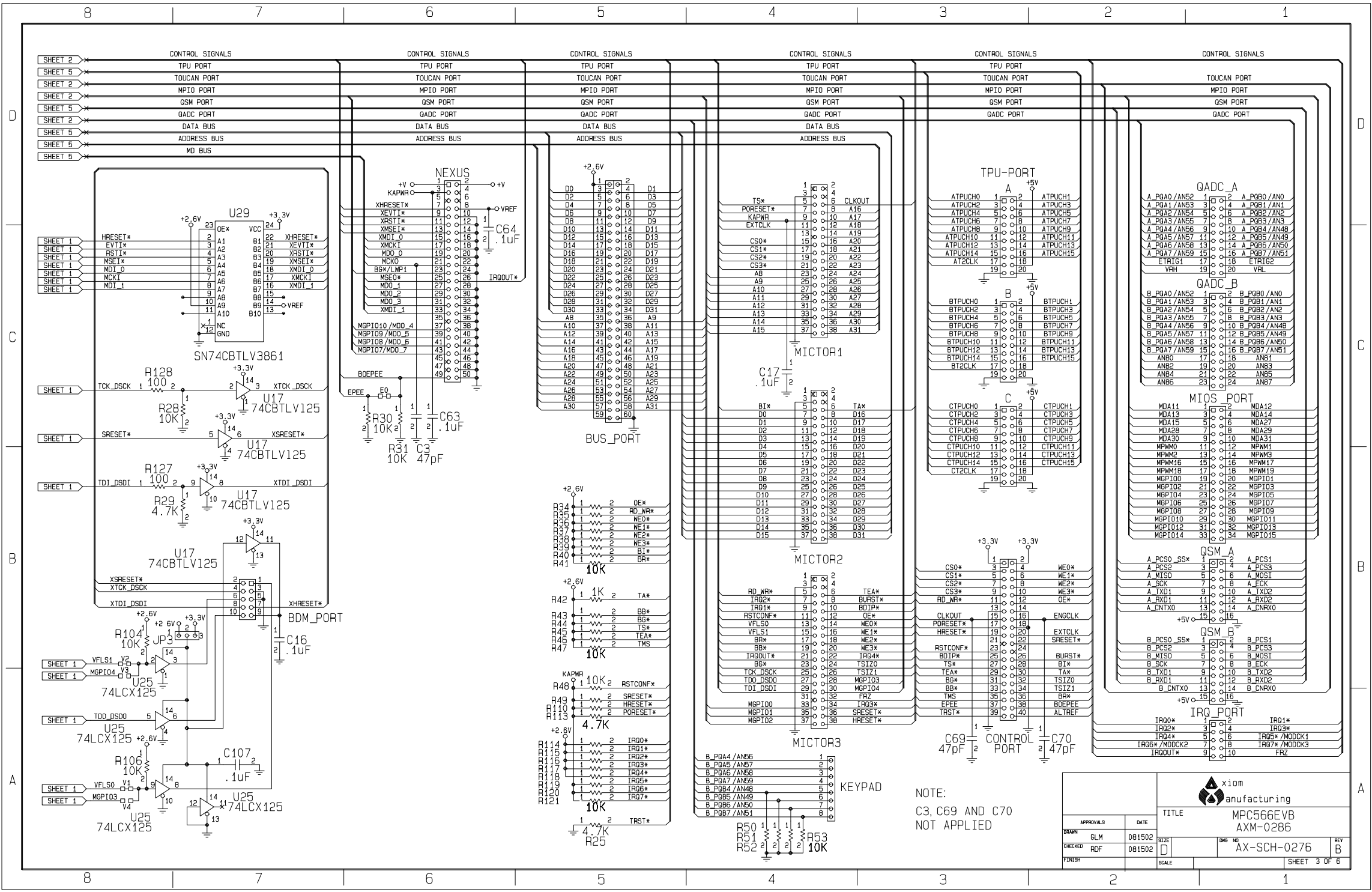

NOTE:  
C3, C69 AND C70  
NOT APPLIED

APPROVALS		DATE	TITLE	
DRAWN	GLM	081502	MPC566EVB AXM-0286	
CHECKED	PDF	081502	SIZE	DWG NO
FINISH	SCALE		D	AX-SCH-0276
			REV	B
			SHEET 3 OF 6	

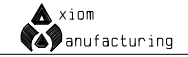

DATA BUS  
CONTROL BUS  
ADDRESS BUS

COM\_PORT  
A\_TXD1  
A\_RXD1  
A\_TXD2  
A\_RXD2  
B\_TXD1  
B\_RXD1  
B\_TXD2  
B\_RXD2

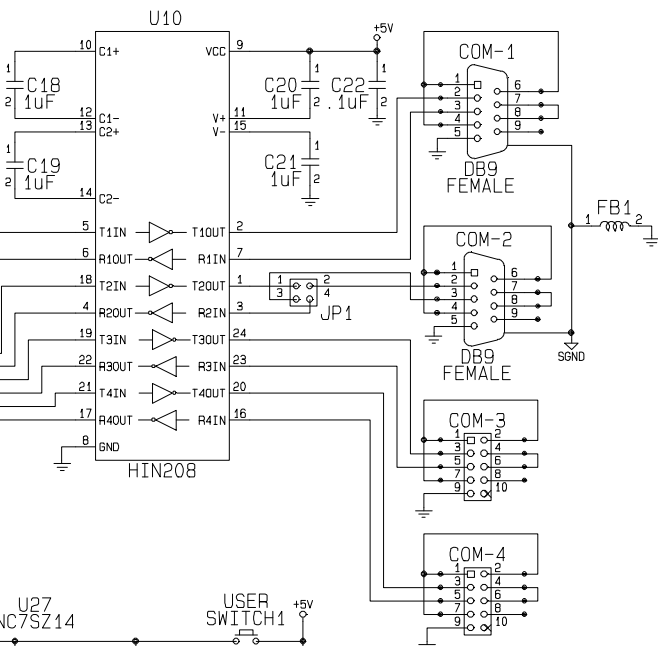
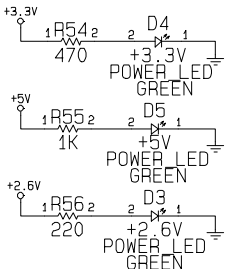
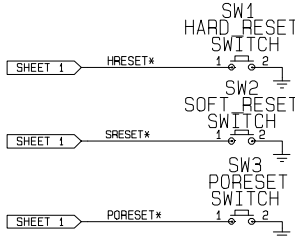
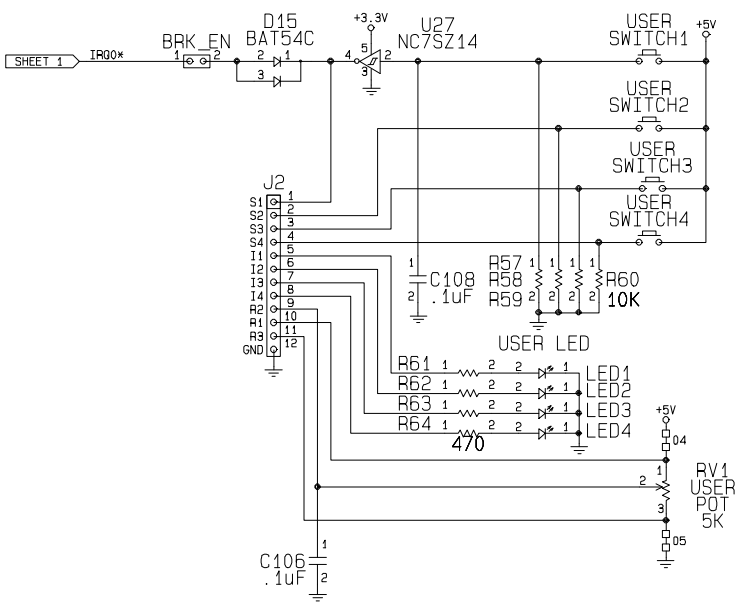

NOTE:  
U5 - 74LX14 & U16 - 74LX32 POWER = +3.3V

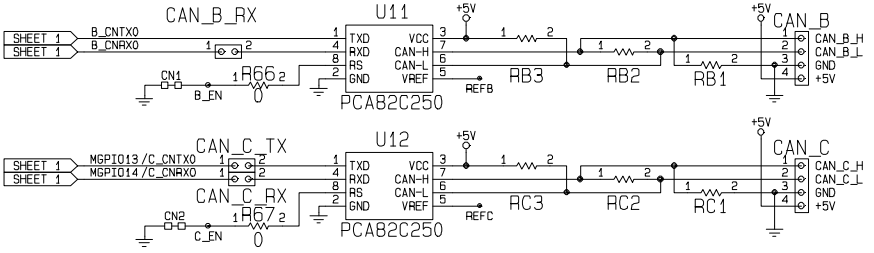
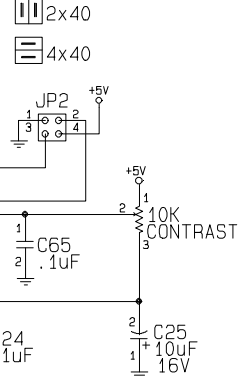
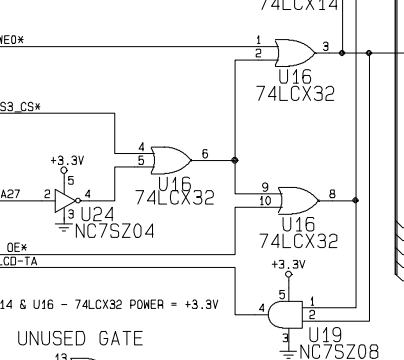
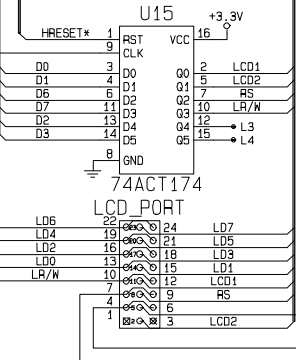
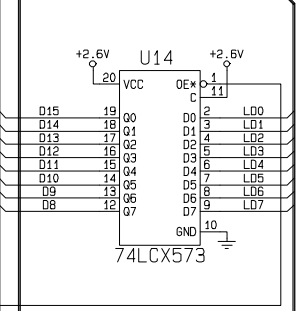
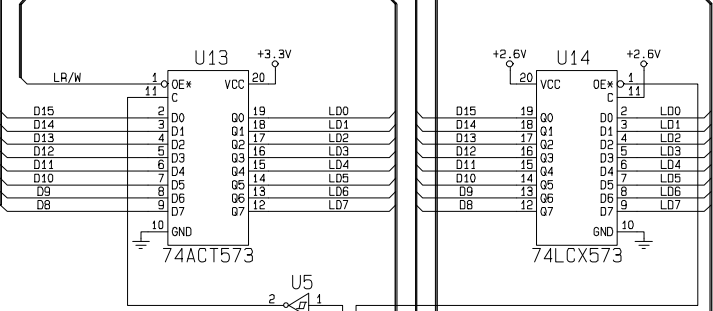
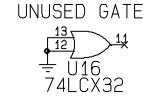

APPROVALS		DATE		TITLE	
DRAWN	GLM	081502		MPC566EVB AXM-0286	
CHECKED	PDF	081502		DWG NO	AX-SCH-0276
FINISH				REV	B
SCALE				SHEET 4 OF 6	



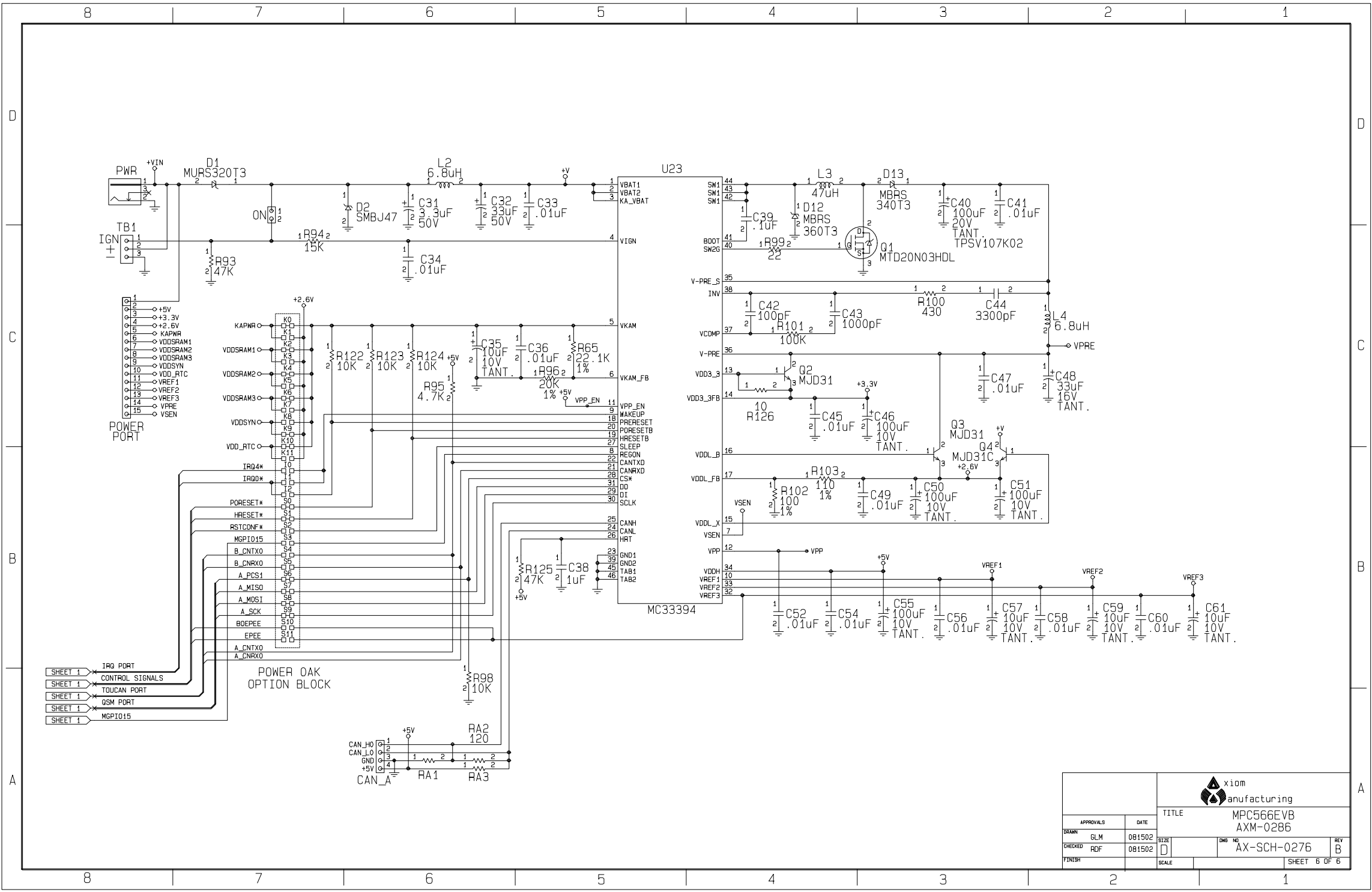

- SHEET 1 → IRQ PORT
- SHEET 1 → CONTROL SIGNALS
- SHEET 1 → TOUTCAN PORT
- SHEET 1 → GSM PORT
- SHEET 1 → MGPIQ15

POWER OAK  
OPTION BLOCK

		TITLE MPC566EVB AXM-0286			
APPROVALS	DATE	SIZE	DWG NO	REV	
DRAWN GLM	081502	D	AX-SCH-0276	B	
CHECKED PDF	081502				
FINISH		SCALE			SHEET 6 OF 6