

DEM09S08SV16/FL16



AXIOM
 manufacturing
 www.axman.com



AXM-0479
 REV A

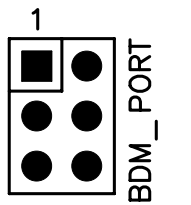
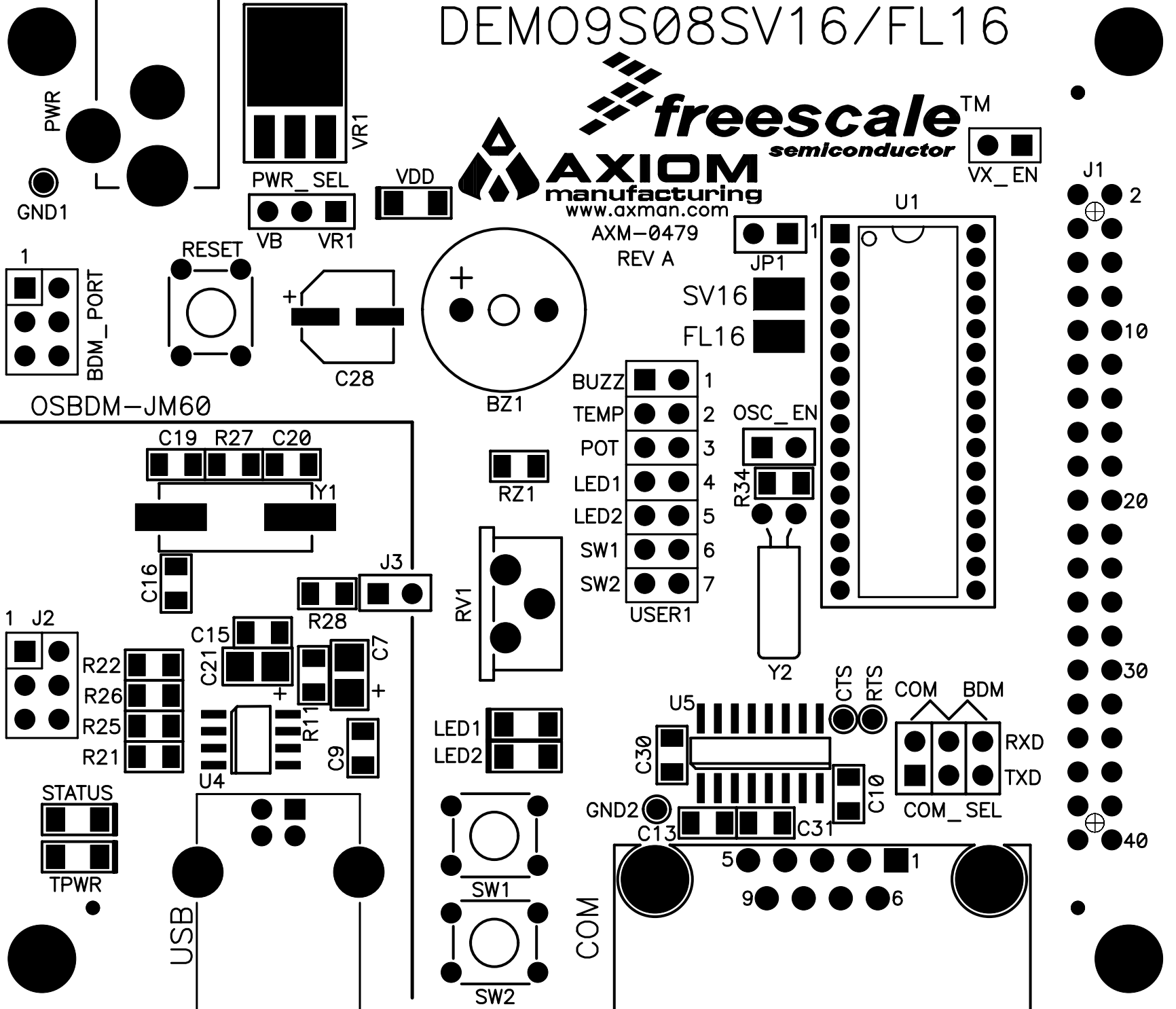

OSBDM-JM60

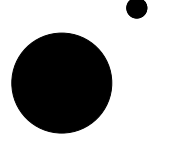
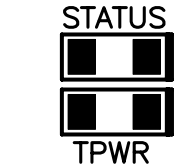
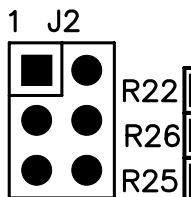

USB

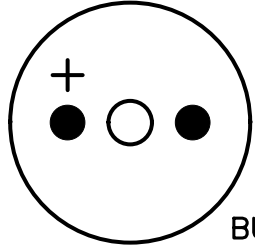

BZ1



RZ1

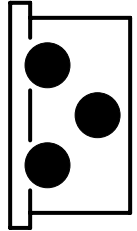

RV1

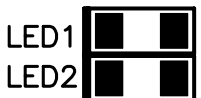

LED1

LED2

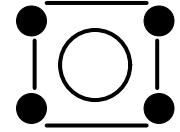

SW1

SW2

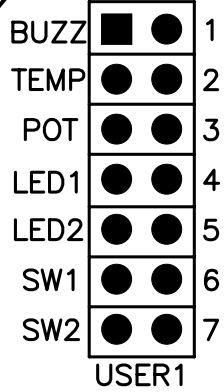

USER1

COM

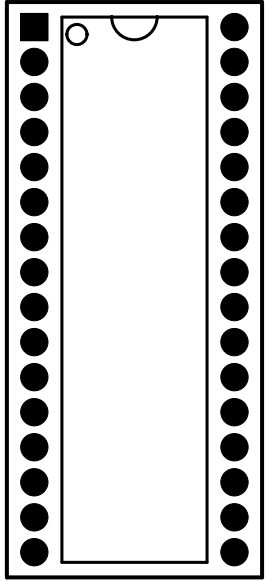
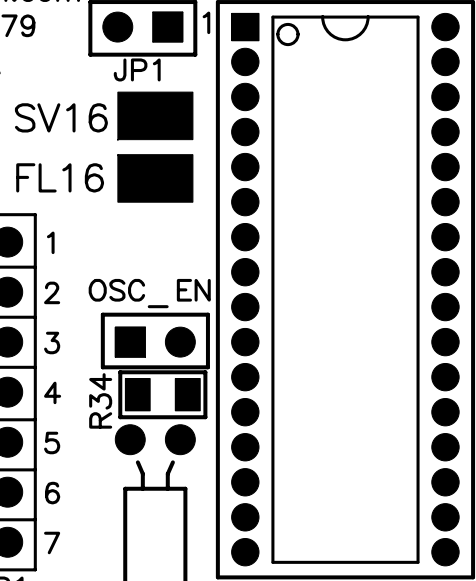
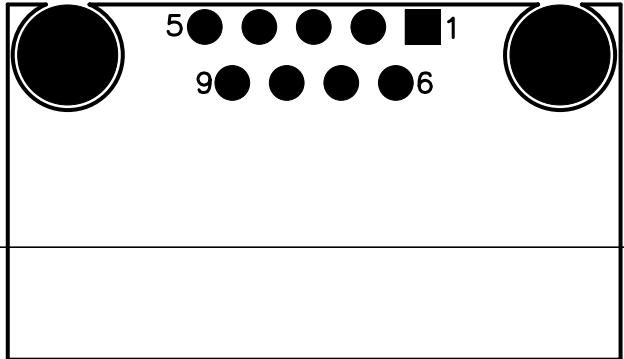

U1

U5

CTS

RTS

COM

BDM

RXD

TXD

COM_SEL

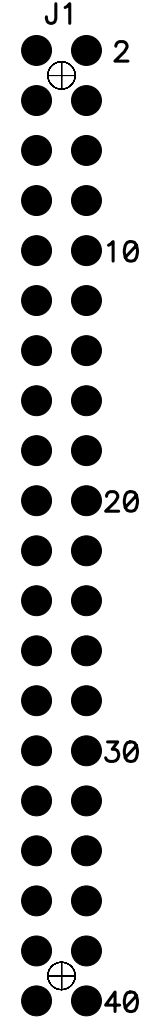

J1

2

10

20

30

40